

THE MODULAR BUILDING SOLUTIONS



IMPRINT

MBS GmbH
Römerstraße 15
D-47809 Krefeld

Managing Director:
Gerhard Memmen-Krüger
Nils-Gunnar Fritz

Register court:
Krefeld HRB 3337
USt.-IdNo.: DE 120 148 529
Headquarters: Krefeld

Responsible for contents
according to § 6 MDStV:
Gerhard Memmen-Krüger
Nils-Gunnar Fritz

TABLE OF CONTENT

3	MBS
4	QUALITY
5	SERVICE
6	DEVELOPMENT
7	COMMISSIONING
8	THE ACCREDITED TESTING LABORATORY
10	SEMINARS SUPPORT
11	TEST DEVICE SERVICE WIKI
12	HARDWARE-SOLUTIONS
14	COMMUNICATION PROTOCOLS
15	APPLICATION EXAMPLES SIEMENS
16	SOFTWARE-SOLUTIONS
18	BACNET STACK (Third Party Product)

MBS GMBH

MBS has been an innovator in industrial and building automation for more than 30 years, delivering state-of-the-art hard- and software and assisting our customers in solving their technical needs.

The MBS Universal gateways are based on the same product platform and therefore offer an extraordinary degree of versatility and flexibility for adapting to changing requirements – an advantage that results in especially low total costs. In addition, MBS offers full service, customized software and hardware development, OEM products, consulting, training and support and on-site commissioning.

MBS has been an active member of the BACnet Interest Group Europe (www.big-eu.org) since 1999 and actively supports the marketing (WG-M) and technology (WG-T) working groups and the advisory board with development and marketing activities relating to BACnet.

As manufacturers we offer you comprehensive expertise and a wide selection of products that meet all your requirements -
Made in Germany.



QUALITY

**DEVELOPING AND
MANUFACTURING
INNOVATIVE HARDWARE
SINCE 1987**

We earn our customers' trust with reliable products and services, timely delivery and perfect support for their business-critical applications.

In order to meet your expectations, MBS fosters a culture of innovation and responsibility, thereby ensuring continuous improvement of our products and services through our quality management system.



THE ALL-ROUND CARE-FREE PACKAGE

"Service" is a stretchable concept, and everyone connects something different. This makes it all the more important to have certainty in building automation. Gateway solutions, which are a key component in building technology, are critical for projects. Failures of hardware or software can not afford in the building control technology, because of the data flow and the connected processes - profan said - money.

The MBS expertise is not only to develop robust, flexible and powerful hardware for building automation. With our service we offer preliminary consultation and implementation of solutions, a comprehensive service and support program that supports our customers in every conceivable problem around their building automation.

- Development
- Commissioning
- Laboratory | Project planning
- Seminars
- Support
- Test equipment service

DEVELOPMENT



Software development

As an IT service provider, we have been developing tailor-made solutions for our customers for 30 years. We also gladly offer you the development of an individual software.

In order to find an effective solution, we first analyze the perspectives of the project with you. Subsequently, we develop a requirements and specifications as well as the entire management of the software development process. Our project management not only assists you throughout the development phase, but also beyond.

No matter how complex your requirements – our software experts look forward to implementing your project.

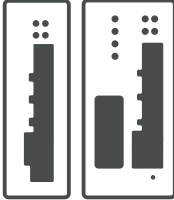

Hardware development

Our experienced engineers and developers accompany development projects from initial idea to the production of assemblies and devices. We have been developing innovative and tailored hardware solutions for our customers for decades; our services cover circuit design, layout and manufacture of PCBs and prototypes.

Of course we also develop individual firmware for your tailored hardware.



OEM products

We develop and manufacture customized Original Equipment Manufacturer (OEM) products in the areas of: Gateway, Routers and I / O modules - use our know-how for your success.

We also support you in the development and implementation of the training measures of your first-level support and are also available to you in second-level support.

Please understand that we cannot display any OEM products. We believe that manufacturing an OEM product means maintaining absolute discretion regarding the product's actual provenance.

[Learn more >](#)

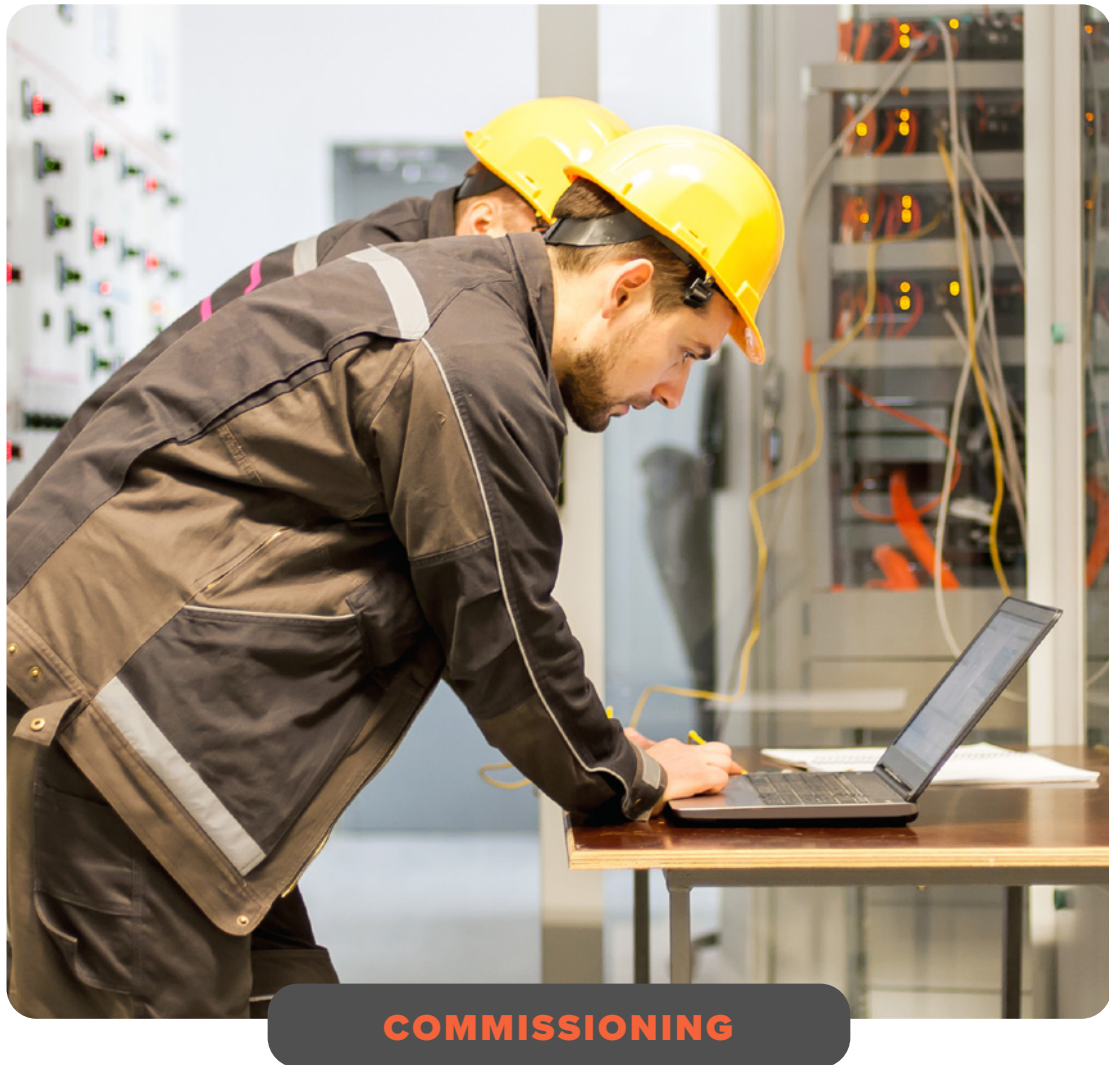

COMMISSIONING

Do you need support during commissioning?

The provision of building services is more than just the installation and configuration of hardware. The requirements for each project are unique and must be considered when developing the right solution. With over 25 years of experience and our own gateway commissioning group, we always have a solution for our customers and partners. We ensure that your project is successful from beginning to end.

With hundreds of implementations, we know your challenges and are well-equipped to ensure a smooth implementation process for your project. To ensure that your system works successfully from the very beginning, we configure our hardware for immediate use according to your specifications. Configuration and commissioning are also part of our services. Commissioning is documented at the end in the form of a protocol. Please contact us!

Working at MBS

CALLING ALL PIONEERS, INVENTORS AND FORWARD THINKERS

We are a dynamic company with creators, artists, problem solvers and people who make things happen. We are proud of having created a corporate culture that is marked by respect, collaboration, integration and innovation. We are curious and creative, questioning the status quo and regularly taking on new challenges. With our hardware and software solutions, we are one of the innovators in industrial and building automation, and we are continuously growing.

Here you can find our current job and internship offers. You can also find the offers on Facebook, Xing, LinkedIn, Twitter und Instagram.

Whether you are seeking a new professional challenge, a new and diversified workplace or would like to start your career with us – at MBS, you are in the right place.

What we offer?

We offer modern workplaces, a flexible induction programme and training opportunities. Open communication is a key principle for us and good ideas are listened to, promoted and acted upon. Here flat hierarchies make for short upward and downward communication paths and quick decision-making.

Who we are looking for:

We welcome applicants who integrate well into a team, are open-minded and reliable, and also demonstrate a high degree of self-organisation. You should have a solution and customer-oriented approach and be enthusiastic about innovations in industrial and building automation.

We always welcome unsolicited applications!

Should you need support for your bachelor's/master's thesis or semester project in engineering or IT, simply contact us. If possible, we will support you here.

We look forward to receiving your application. Please send it by email together with a covering letter, CV, certificates and salary expectations to jobs@mbs-solutions.de.

BACnet Secure Connect

BUILDING AUTOMATION FOR OPTIMUM PROTECTION



At present, some 25 million devices exchange data via BACnet, the first version of which appeared in 1995. Now, with its own security structure, the manufacturer-independent communication standard is fit to face the demands of digitalisation.

Initially, with its closed networks and long innovation cycles, the requirements of building automation in terms of operational safety were very different to those of information technology (IT). Today, however, internet technologies, the convergence of IT and building automation (GA) and cloud-based applications call for a high degree of protection for communications (such as access restrictions, authentication, authorisation, encryption).



Minimising the risks

The aim of the federal government's KRITIS strategy is to safeguard critical infrastructures in order to supply key goods and services to the state, industry and society. From airports and chemical plants to municipal properties, more and more operators of building automation are required to prove that they can guarantee a secure supply. This also applies to BACnet networks, which until recently could only be properly safeguarded at high expense. Now BACnet Secure Connect (BACnet/SC) offers a technology for establishing secure communication links at relatively low cost. After all, current standard practice in IT will ensure the security of networks and information in building automation in future.

A number of challenges will have to be overcome to complete this process effectively. For a long time, there has been a much greater awareness of security in IT circles than in building automation. Anyone who trawls the internet in search of unsecured BACnet networks will quickly find them. At the same time, building technology cannot simply be handed over to a security-approved IT administration without compromising the guarantee of the device manufacturer. We therefore perceive a need for pragmatic ways to implement the new standard so that operators can apply it without problems. Accordingly, the standard now incorporates several mechanisms that have proven effective in the field of information technology.

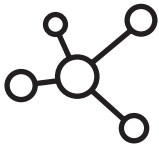

From hub to node

First of all, the network topology of BACnet/SC looks different. Previously, broadcasts were used for initial connection attempts in BACnet, partly with the support of BACnet Broadcast Management Devices (BBMD) – not a commonplace method in the IT field. A different approach has now been chosen for the configuration: every network has a central point known as the hub. This controls data traffic between any required number of nodes (devices) and performs an analysis of data traffic to determine whether information should be forwarded to one node or to all nodes. A direct connection can also be established to ensure direct communication between two nodes.

BACnet/SC also has a failover mechanism which ensures the system remains functional even when the hub fails or is disconnected for maintenance. The new topology significantly simplifies configuration, commissioning and administration, while BBMDs and the configuration thereof become superfluous.

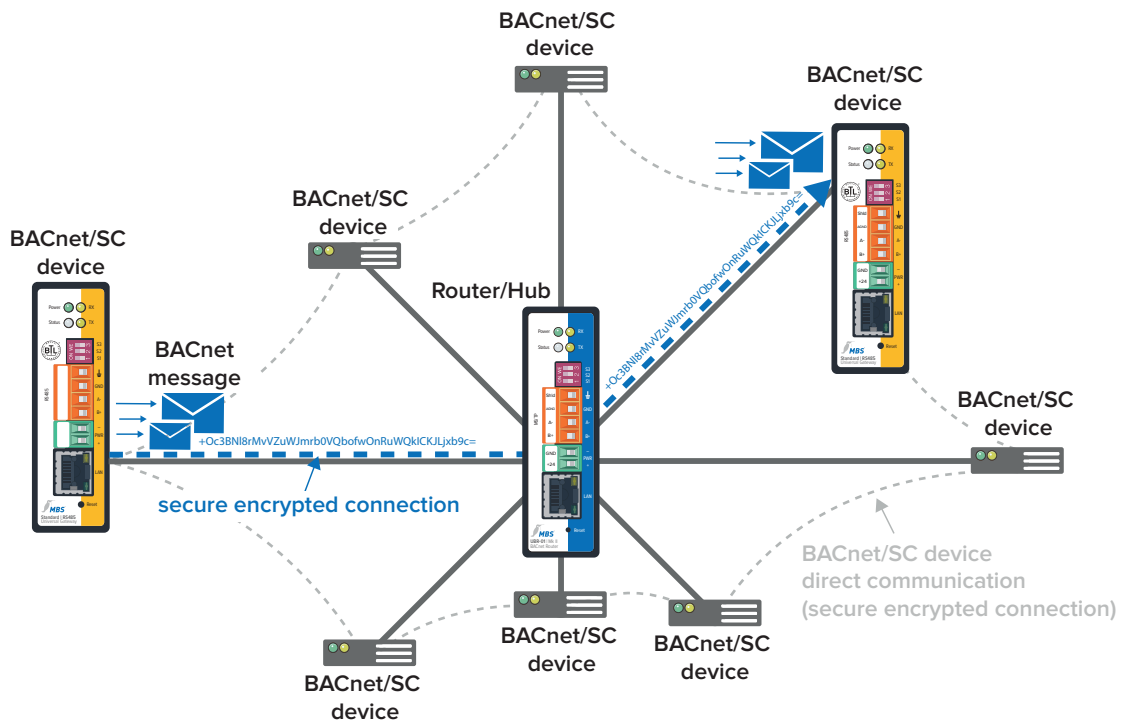



Encryption and certificates

TCP (Transmission Control Protocol) and WebSocket – two reliable mechanisms based on the internet protocol (IP) widely used in IT – are used for secure data transmission. TCP/IP replaces the UDP (User Data Protocol) network protocol layer previously used by BACnet; TLS is used to ensure bug-proof and tamper-proof communications. TLS (Transport Layer Security) is also widely used as the foundation for secure internet access (https) in IT.

As far as encryption is concerned, a company-wide procedure must be put in place for the necessary digital certificates. The certification and registration authorities responsible for the internet in connection with public key infrastructures are not specified in BACnet/SC. This means building automation operators can take account of their individual network structures.

To ensure problem-free implementation in existing networks, the security mechanisms have been defined in BACnet as an additional data link layer. The new standard in the latest revision (22) is also downwardly compatible. The advantage of this is that the existing system can always communicate with the new BACnet/SC devices via appropriate routers. A secure investment is therefore assured.

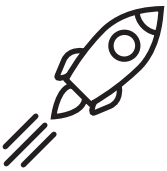

Start now!

BACnet/SC is still in its infancy; no doubt it will be several years before the standard is rolled out across Germany and the rest of Europe. It looks like the first manufacturers with the necessary devices for making a BACnet network SC-compatible are entering the market. However, waiting to see how things develop is not an option: However, waiting to see how things develop is not an option: operators should take action now. After all, setting up or expanding a network with BACnet/SC-compatible devices is not enough in itself to provide security; establishing an awareness of security amongst all persons involved with BACnet networks will be essential.

Operators should also familiarise themselves with the details of revision 22 in order to plan for the changeover: what will it mean to switch from UDP to IP with TLS? From a technical viewpoint, what is needed to make the changeover as smooth as possible? Will extra devices or lines be required? What must be done to create and sign digital certificates and load these on field devices? What tools are available for the changeover? How can we take advantage of existing IT mechanisms?

As regards the new product range, BACnet/SC is a technology that most operators of building automation will seek to implement in the future. It is possible that smaller companies will be faster to enter the market with new products than larger organisations. Seeking out manufacturers that were involved in developing the latest revision may be worthwhile. It may also be useful for property operators to take advice by joining a general or company-specific training course; this is one way to ensure BACnet/SC is successfully applied to a specific property.



MBS is out ahead

As far as the new product range is concerned, BACnet/SC is a technology that most GA manufacturers will implement in the future. MBS GmbH, the company that was a big part of the Revision 22, is also splashing out on upgrades for its products. In past years, together with Delta Control, the company has already been providing all manufacturers with a free test environment for secure communication with BACnet/SC. This was the first German cooperation to offer encrypted data transmission via the internet for a distributed test network.

Now, with BACeye/SC, the popular software for network diagnostics is available making commissioning, maintenance, diagnostics and repairs significantly easier for building automation networks. BACeye/SC combines the features of the tried-and-tested BACeye 2.0 tool with the full range of functions of BACnet/SC – including access restriction, authentication, authorisation and encryption. It can be used in protected communication environments and allows for encrypted browsing. Products like these ensure BACnet/SC is successfully applied to a specific property.

BACnet Secure Connect

PLUGFEST WITH BACnet/SC

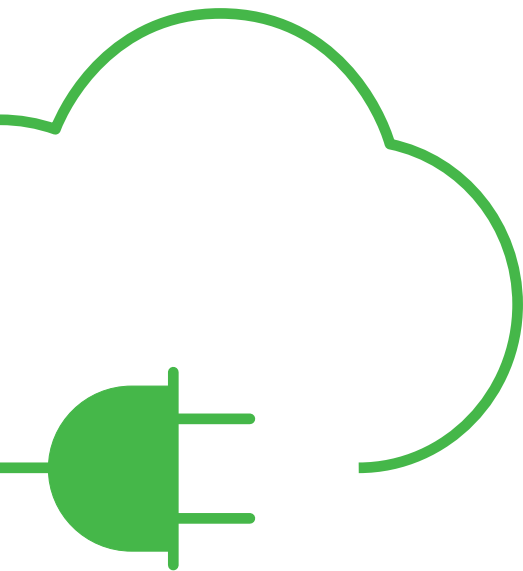

MBS and Delta Controls invite manufacturers to virtual Plugfest with BACnet/SC

Shared network for testing with Secure Connect now and in future online available to device developers free of charge

A test environment for secure communication with BACnet/SC, set up on the initiative of Delta Controls and MBS GmbH, is now available to all manufacturers. In the past year BACnet, the open standard for data exchange in building automation, has been expanded to include the security infrastructure Secure Connect (BACnet/SC). This makes it the first German cooperation to offer encrypted data transmission via the internet for a distributed test network.

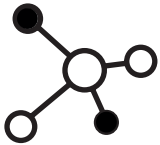

Multi-vendor communication with BACnet/SC

“We are inviting all manufacturers to link up to our virtual platform free of charge,” says Dusko Lukanic-Simpson, Managing Director of Delta Controls Germany GmbH in Leinfelden-Echterdingen. “Our objective is to establish multi-vendor communication capable of demonstrating to property operators that data exchanges are effective and secure with BACnet/SC.”

The motivation for the partnership emerged from consistent application of the new security infrastructure. Delta Controls linked test set-ups for its enteliWEB building control system to BACnet/SC at its various company sites. A search was carried out for manufacturers already using the new security infrastructure, and MBS was discovered. As the company’s universal router UBR 01, gateways and software products were already equipped with BACnet/SC – and several past projects had been completed successfully – another straightforward cooperation was launched.

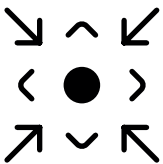

Focus on collaboration

The result is a virtual platform based on the BACnet/SC connectivity mechanism. This is used by both companies to map the interplay of incorporated Delta and MBS products and to review the security of data communications. “The development of Secure Connect is very close to our hearts on both sides, and that’s what made cooperation possible,” stresses Nils-Gunnar Fritz, Managing Director of MBS GmbH in Krefeld. “We now have the option of exchanging authorised, authenticated and encrypted BACnet data via the internet.”

The two BACnet/SC pioneers welcome any manufacturer wishing to join them on this path, and they are pleased to make their network available. After all, the fact that the open bus protocol guarantees smooth processes is more than just a technological aspect for them. “Interoperability means exchanging data in order to resolve problems in partnership. It’s a philosophy that puts collaboration front and centre,” points out Lukanic-Simpson.



Implementing BACnet/SC now

The initiative has arrived at the right time. Projecting the somewhat long-term innovation cycles in building automation onto the introduction of Secure Connect is to underestimate the urgency fuelled by current trends such as cloud services and the Internet of Things. “Our practical example has shown that BACnet/SC works,” says Fritz. “We now have a network that can be used as a test system, regardless of location, and we also have the relevant tools – so implementation can begin.”

BACnet Secure Connect

SWITCHING TO BACnet/SC

Creating a comprehensive infrastructure of BACnet/SC-compatible devices is one way for property operators to take advantage of BACnet Secure Connect (BACnet/SC) in building automation. However, when you consider that around 25 million end devices currently transfer their data via BACnet, it soon becomes clear that a complete switchover would involve significant effort and expense.

Those hoping to update their existing devices instead (an update that is still inconceivable) should consider that existing hardware may not be equipped for the computing power required by BACnet/SC.

It is therefore useful to plan for a transition, combining existing BACnet/IPv4 infrastructure (Internet Protocol version 4) with BACnet/SC-compatible hardware. When integrated into traditional infrastructure, this combination not only serves as a bridge between BACnet and BACnet/SC, it also allows users to physically encapsulate data exchange via BACnet/IP. This allows for secure, encrypted data communication in building automation.

The following three graphics show the common network topologies for building automation with BACnet and aims to provide suggestions on how to successfully switch over to BACnet/SC.

In principle, the topology of traditional networks must be changed to make them fit for BACnet/SC. In doing so, each network receives a central point in its configuration. This is called the hub. This hub

controls data traffic between any required number of end devices; and

analyses data traffic to verify how many end devices information should be sent to.

The Universal BACnet Router (UBR) from MBS can take on this role. Located in the local management system network, the device has been used for implementing ISO 8802-2 BACnet network topologies (also known as BACnet/Ethernet), BACnet/IP and MS/TP (serial BACnet networks based on RS485) for quite some time. In the meantime, it also supports the current BACnet Revision 22 and can therefore be used to build the innovative BACnet/SC security structure. The UBR-01 contains one network card, the UBR-02 contains two. Which device can be used depends on the specific circumstances.



Connect across systems over the Internet with BACnet/SC

Starting point

A hub with locations across the world that are connected to one another via the Internet. Currently, data exchange in building automation via BACnet/IPv4 would only be possible if all locations were connected via VPN. Application examples include a company with sites across the globe, authorities with affiliated schools and gymnasiums, or a supermarket chain with its various branches.

The hub contains the building control system, which accesses building automation systems. The interface to the World Wide Web comes in the form of an Internet router with a firewall.

The challenge

Data exchange via IPv4 is unencrypted. The DHCP (Dynamic Host Configuration Protocol) control protocol for automatic assignment of IP addresses (useful when managing large networks) is also not supported. Complex VPNs (Virtual Private Network) were previously set up to secure such building automation networks.

The solution

In this example, the Internet router transmits the data to the UBR-01, which then serves as a media converter to translate the BACnet/IPv4 data protocol into BACnet/SC using its built-in network card. It also encrypts the data communication.

Connecting to the hub

The hub's Internet IP router has either a static IP address from the Internet or its dynamic address is resolvable via a dynamic DNS. Extensive data packages are forwarded to a UBR-01 via a defined port (port forwarding). The UBR-02 acts as an SC hub and BACnet router here to allow users to continue to use a building control system with BACnet/IPv4.

Connecting locations

Two versions are shown below the central control centre, outlining how, in this scenario, the building-related systems at the various separate locations can be connected to the control technology.

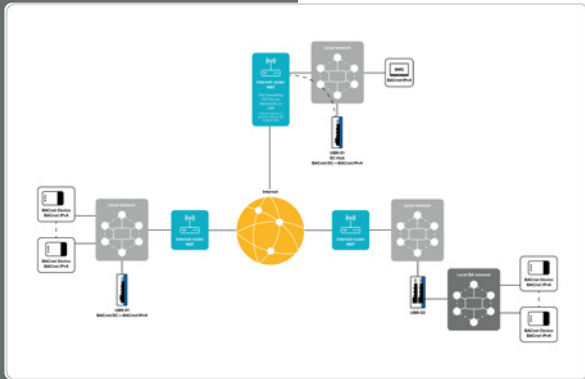

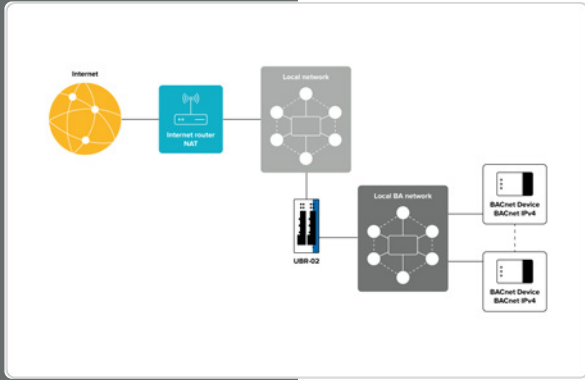

Description of the graphic on the right

On the right side, a router is used for transmitting data between local systems and the Internet, e.g. an IP-compatible DSL router. This does not have to be compatible with port forwarding. The local networks include both internal networks with BACnet/IPv4-compatible devices for building automation and other end devices, such as PCs in administration. Communication is not divided, meaning the other devices in the network can see the IPv4 traffic in BACnet and potentially influence it.

To make this location fit for BACnet/SC, a UBR-02 containing two network cards can be used. One of the network cards routes the data into the local network for building automation. The network's end devices are therefore separated from other devices in the rest of the local network and thus secured. The second network card connects the site network to the BACnet/SC hub in the control centre using the local Internet router. This allows for communication between the location and hub for encrypted data transmission.

Conclusion

The UBR-02 can ensure the most security for locations that only have a single Internet connection that is used by the whole building automation network.

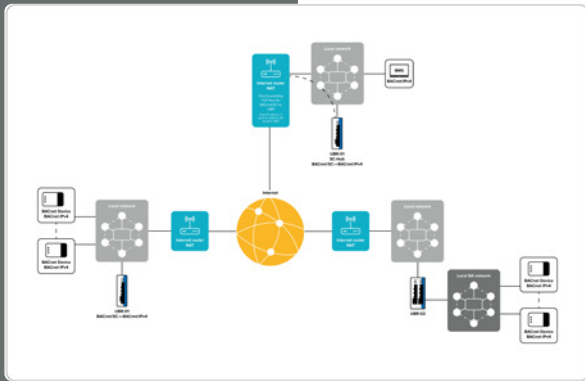

Description of the graphic left side

The scenario on the left side shows a similar local network at a company location. However, this scenario does not involve any other end devices other than BACnet/IPv4-compatible devices for building automation. For transmitting data between a local network and the Internet, an IP-compatible DSL router is also used (does not have to be compatible with port forwarding) as there is no need for static or dynamic IP addresses here.

In contrast to the scenario on the right side, however, the existing BACnet is translated into BACnet/SC and thus encrypted using a UBR-01 (with just one network card). The UBR-01 also uses the same network card to encrypt communication with the building control system via the DSL router.

Conclusion

This simplified set-up can be useful if the local network does not contain any other devices and the Internet connection is used solely for building automation.

BACnet/SC in a campus network (variant 1)

Starting point

A hub in a campus network with lots of participants that are interconnected via an intranet. Data exchange in building automation is currently carried out via BACnet/IPv4. Hospitals or university campuses are examples of this.

The hub is found in the building control system, which accesses the building-related systems in individual offices and building groups via an intranet. The local networks include both internal networks with BACnet/IPv4-compatible devices for building automation and other end devices, such as PCs in administration.

The challenge

These systems are virtual islands within local networks which exchange their data with BACnet/IPv4. The data packages are sent without encryption and can be viewed (and potentially changed) by all participants in the network.

The solution

A UBR-02 can be used to physically secure building-related systems. Both of its network cards allow users to separate campus and building automation networks: one network card is used to exclusively route BACnet data between both networks. The second network card is used to enable campus communication with BACnet/SC. The data traffic can no longer be viewed by participants outside of building automation thanks to encryption.

Conclusion

The UBR-02 can ensure the most security in a local campus network.

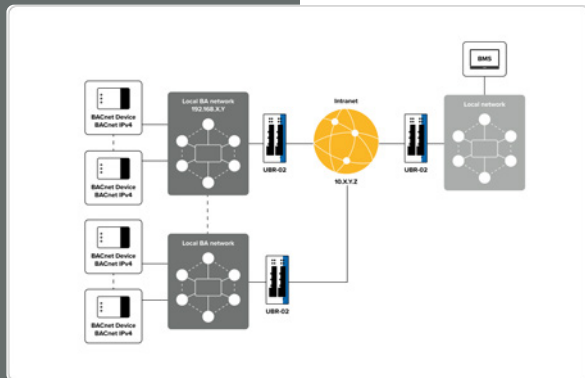

BACnet/SC in a campus network (variant 2)

Starting point

A hub in a campus network with lots of participants that are interconnected via an intranet. Data exchange in building automation is currently carried out via BACnet/IPv4. Hospitals or university campuses are examples of this.

The hub is found in the building control system, which accesses the building-related systems in individual offices and building groups via an intranet. A local IP sub-network for general data traffic is shown on the right side. The local building automation network is shown on the left. Both sub-networks are connected to the network via an IP router.

The challenge

These building-related systems are virtual islands within local networks which exchange their data with BACnet/IPv4. The initial connection in BACnet is established using so-called BACnet Broadcast Management Devices (BBMD), which can be time-consuming to configure. The data packages are sent without encryption and can be viewed (and potentially changed) by all participants in the other sub-network.

The solution

A UBR-01 can be used in both sub-networks to physically secure building-related systems. Each of its network cards can be used to exclusively route BACnet/SC data into each sub-network. This ensures that data traffic on the intranet is encrypted. In addition, the individual devices no longer communicate individually via the intranet and instead communicate via the UBR-01.

Conclusion

The UBR-01 can provide the most security in a local campus network with sub-networks and makes configuring end devices much easier.

Our tip: MBS GmbH can support businesses in transitioning from BACnet/IPv4 to BACnet/SC:

- property inventory
- network analysis
- development of suggestions for solutions and their implementation
- delivery
- installation of BACnet/SC-compatible devices
- as complete service or individual service (e.g. including training).

Contact us – we're happy to help.

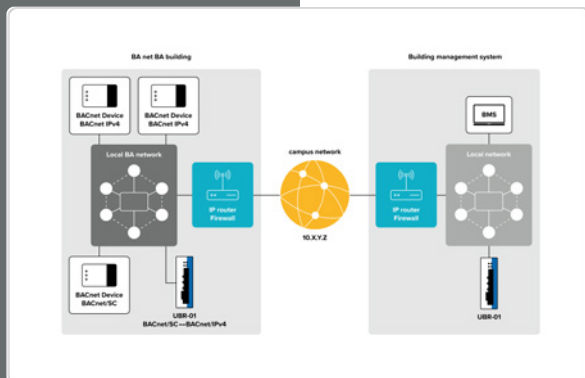

Before - After representation

BACnet/IPv4 - BBMD — BACnet/SC

BACnet in the campus network

BACnet/IPv4 - BBMD

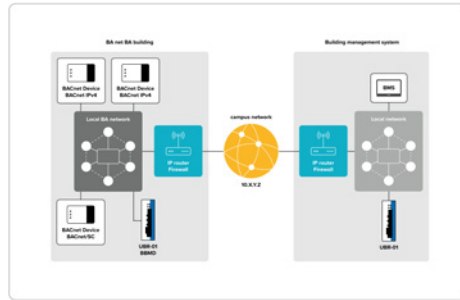

BACnet/SC

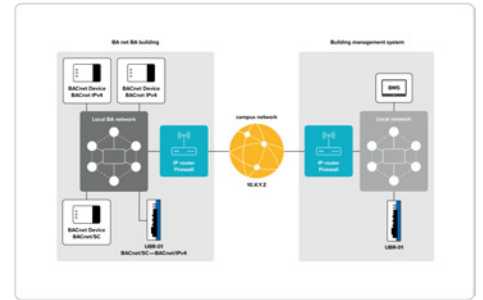

Firewall options

Firewalls must allow for UDP (User Datagram Protocol) from each BACnet device in the network to every other BACnet device.

Firewalls can restrict BACnet traffic with TCP (Transmission Control Protocol) to the BACnet/SC router in the individual sub-networks.

IP configuration of individual BACnet devices

Each BACnet device must be configured to the local IP router/firewall so that it can reach all other BACnet devices (e.g. using a default route).

The BACnet devices must only communicate with other devices (including SC route in the local building automation network) directly. Internal IP routing across the entire campus network is not necessary.

Security in the campus network

The BACnet traffic in the campus network is unencrypted and unsecured via BACnet/IPv4.

The BACnet traffic in the campus network is encrypted and secured via BACnet/SC.

BBMD configuration

required

not required

BACnet TESTING LABORATORIES

READY FOR THE BACNET MARKET ?

PARTNER FOR CERTIFI- CATION - AND BEYOND



More and more operators are using BACnet as a proven protocol for smooth communication between building automation system components.

A certificate and the BTL logo document that there is in fact such smooth component interplay. The certificate is used to identify products which have passed testing at an accredited testing laboratory, like those operated by Krefeld-based company MBS GmbH.

Standard-setting certified products

Manufacturers are not legally obliged to have their BACnet products certified. Frequently, however, in tenders for public real estate the properties' systems must bear the BTL label (BACnet Testing Laboratories), without exception. This label is the seal of quality of both BACnet International and the European BACnet Interest Group, and is for all intents and purposes a must to be able to compete with other market participants. For many tenders in Germany and some in Austria, an attestation must commonly also be provided from AMEV, the Working Group for Mechanical and Electrical Engineering of State and Municipal Administrations. A certificate of conformity from an accredited BACnet testing laboratory is an integral part of this attestation from the start.

It is thus entirely accurate to say that manufacturers of systems/equipment that conform with the ISO 16484-5 standard enjoy a better competitive position. It is no coincidence that prominent German producers have qualified to display the BTL logo, and this has established it as a market standard.

The innovation factor

New developments, innovative features, standard revisions and other technical factors can require a trip to the testing laboratory. An issued certificate is valid for a period of five years. Hardware improvements and software updates implemented during that period require additional testing of the new functionalities. Equipment which has not been upgraded still has to be re-tested upon elapse of the five-year period.

In such cases, the product is sent to one of the four test labs worldwide for conformity testing. The entire functional range is covered here, from simple sensors and actuators, application-specific controllers (B-ASC, B-AAC), freely-programmable DDC (B-BC), gateways (B-GW) and routers (B-RTR) to operating equipment, building control systems and workstations (B-OD, B-OWS, B-AWS). The testing process is as defined in the official BACnet Test Package, consisting of the BTL Testing Plan and Test Standard ISO 16484-6.

The German Accreditation Body, DAkkS, regularly audits labs in Germany to ensure conformity with laboratory standards and quality requirements. The DAkkS certifies lab competency to carry out conformity testing as the prerequisite for equipment certification.

Quality with no compromises

Testing is generally conducted under BTF, the BACnet Test Framework developed by MBS GmbH. This framework comprises software that automates a large part of the testing procedure, which can take several months even with this automation, depending on the scope of the equipment's functionalities. If this seems like an involved and burdensome process, you should consider the substantial benefits it affords.

First of all, conformity testing ensures quality. A manufacturer can then be assured that its product works in accordance with the standard and properly interfaces with other BACnet equipment. Secondly, equipment that has passed testing communicates with other components (which also bear the BTL logo) on an out-of-the-box basis after installation in a building automation system.

Thirdly, support costs are significantly reduced, as system failures and disappointed customers become a thing of the past.

Choosing the optimal service provider

Any company, located anywhere, can have its products tested at any accredited testing lab. Testing is always carried out on the basis of the official BACnet Test Package. Upon successful completion, permission to use the BTL logo is granted and the company is entered in the BTL Certification Listing, which is the international register for all products which are documented as BACnet-conforming.

The service provider selected should be the one most suitable for meeting your particular needs. MBS GmbH has its own testing laboratory manned by ten experienced employees, which has been accredited by DAkkS since 2012. At this facility, the company deploys its extensive experience as an equipment and software manufacturer for building automation and its twenty years of involvement in international committees. You could even say that MBS has BACnet in its DNA. This means customers benefit from an array of services, which are also available as a complete package. These include development aids for companies getting started, detail-level training on the standard and assistance with product development and implementation.

Your partner for certification... and more

Pre-testing is an available option in case of doubt concerning equipment conformity. Pre-testing is also carried out based on the BTL Test Package but costs substantially less, as in regular lab testing, a single error may for example require multiple test rounds. Such official conformity testing is of course also carried out at the MBS testing lab.

The lab experts are the ones to turn to for assistance with any BACnet-related matters, such as support with error analysis and log file evaluation. MBS is also a reliable partner for help in dealing with certification bodies to clarify certain issues

Please contact us!

SEMINARS



MBS seminars

MBS Seminare (Only in German language available)

As a specialist in industrial and building automation, it is important to us that we provide you or your employees with in-depth knowledge of our technologies and products. We offer special training for all of our products as well as general basic training in the handling of various bus structures.

Our goal is to show you solutions for your daily tasks, naturally also in an individually tailored seminar if required. We will convey the relevant facts to you in our seminar rooms in Krefeld, if necessary also in your premises or as part of the installation process.

[Learn more >](#)

SUPPORT



We stand side-by-side with you.

As a provider of solutions in the field of building automation, we at MBS know that it is not sufficient to merely provide the customer with a quality product. Our customers can expect long-term support even after the purchase of a device.

MBS experts answer technical questions by phone or online. If a user needs immediate help with a technical problem, they can contact Support at any time. We use a ticket system to manage queries. This ensures that after contacting us you will receive a fast response from our service personnel and your problem will be handled quickly.

Our trained customer service representatives provide you with support in German and English.

[Learn more >](#)

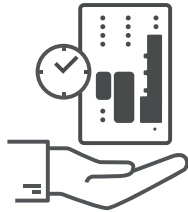

TEST DEVICE SERVICE

Test us and form your own opinion

We are pleased that you would like to test products from the MBS product range. We would be happy to follow up on your interest by providing you with the required products. Without a doubt you will already have informed yourself thoroughly about our products and may even have received advice from our customer service team – with a test, you can now convince yourself of the benefits of our products, as well as of the efficiency and strong customer focus of our service department and our company.

[Learn more >](#)



WIKI

WIKI pages of MBS

In order to give you a smooth and easy start when configuring our gateways we offer this WIKI as a useful reference. You will find here technical features of our gateways, the necessary know-how, a description of the most common protocols and the „Dispatch“ mechanism. Additionally there is an FAQ section dealing with the most important questions around installing our gateways on-site.

[Learn more >](#)



01



FAST INTEGRATION



WEBINTERFACE



UPGRADEABLE



AUTO CONFIG Ready



MANY DATAPPOINTS



ADDITIONAL INTERFACES



NUMEROUS PROTOCOLS



SIEMENS ST-CPU READY



MEMORY CARD



MADE IN GERMANY

X-Series Gateways

The MBS Universal Gateways serve as the communication interface for the various communication protocols in industrial and building automation. All important communication protocols are available, the MBS Universal Gateways offer the right solution for almost every requirement.

The MBS Universal Gateways offer unique flexibility and enable fast cabling and connection. The integrated e.g. KNX, LON, M-Bus or PROFINET-adapter enabling faster connection to serial or network-based communication protocols.

[Learn more >](#)

Gateway Configurator

Are you looking for a translator from one communication protocol to another?

With its numerous available communication protocols the MBS Gateway offers for nearly every requirement the right solution. On request, proprietary protocols can be implemented. Select your communication protocols and data points as required. You can send than the gateway recommendation directly from the configurator as a request.

[Learn more >](#)

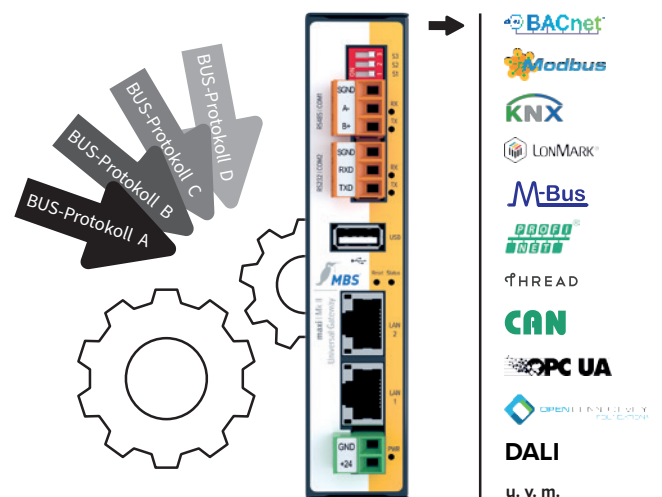

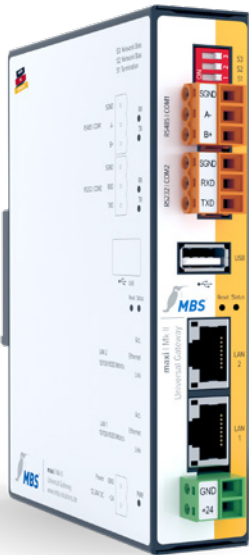

02

The A-Series

The MBS Universal Gateway maxi | Mk II from the MBS A Series for demanding building automation applications: smaller dimensions and a maximum of 40,000 data points.

maxi | Mk II

Operators of large properties need plenty of space in which to set up the necessary infrastructure. So it is ideal if the individual technical elements in an automation system take up as little room as possible.

MBS's latest product in its proven maxi gateway series is the maxi | Mk II: a communication interface with impressive features. Small in size and with a maximum of 40,000 data points, it is the most compact and yet the most powerful gateway currently on the market.

[Learn more >](#)



03

Router

Like media converters, the MBS Universal BACnet Router connect BACnet networks of different technologies such as BACnet/IP, BACnet Ethernet, BACnet MS/TP and BACnet over LonTalk.

UBR-01 | Mk II

The UBR-01 enables the implementation of the BACnet network topologies ISO 8802-2, BACnet / IP and MS / TP.

UBR-02

The UBR-02 routes packages between the MS/TP media (RS485), Ethernet and IP, which can be linked to create a common network. It can link two separate IP areas with two network connections.

[Learn more >](#)



04

Level Converter

LC 30 | M-Bus/USB Level Converter

Level converters are used to supply connected devices with electricity in an M-Bus system. The electricity requirement is counted in "standard loads".

To expand the number of supported standard loads in an M-Bus system, the available systems often need to be expanded. The M-Bus/USB level converter from MBS does just that. It is equipped with one M-Bus and one USB connection and is used where consumption data is read with M-Bus and needs to be transferred to an M-Bus master with a free USB port. Each device is designed for up to 30 standard loads of 1.5 mA each and therefore for a maximum of 30 counter units.

[Learn more >](#)

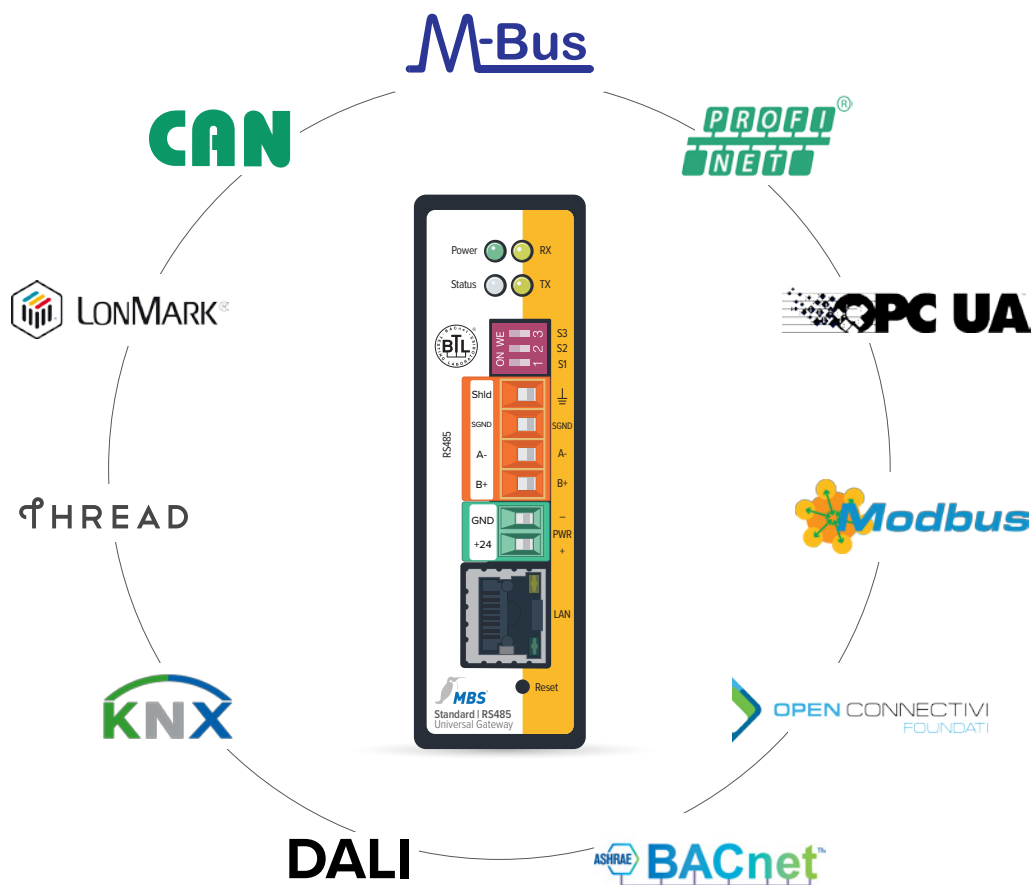

All major communication protocols are available

With their wide range of available communications protocols, MBS gateways offer the right solution for almost every requirement. Manufacturer-specific protocols can also be implemented on request. The gateways are configured using text files. These are transferred from an integrated web server to the gateway via a web browser. The configuration is permanently saved on the gateways – and optionally as a backup in the dropbox (Internet connection required).

APPLICATION EXAMPLES FROM SIEMENS

Communication between a SIMATIC SPS (S7-CPU) and a MBS Gateway

Are you looking for an application description for communication between a SIMATIC SPS and an MBS gateway model in a BACnet network?

For information on the configuration of SIMATIC SPS and PROFINET, see the [Siemens Support page](#) or download the corresponding information there.

We support the following Siemens control systems:

- **S7-1200**
- **S7-1500**
- **S7-300** with PROFINET CPU or appropriate PROFINET communication module

If the required PLC is not listed here, please contact us.

APPLICATION EXAMPLE



**SIEMENS
S7-CPU READY**

This application example demonstrates how to configure communication between a SIMATIC SPS:

and a **DALI network** with a gateway project.

[Learn more >](#)

and a **BACnet network** with a gateway project.

[Learn more >](#)

and a **M-Bus network** with a gateway project.

[Learn more >](#)

and a **KNX network** with a gateway project.

[Learn more >](#)

Communication between PAC measuring devices and an MBS Gateway

Are you looking for an application description for communication between a PAC measuring device and an MBS gateway model in a BACnet network?

For information on the configuration of a PAC measuring device and PROFINET, see the [Siemens Support page](#) or download the corresponding information there.

APPLICATION EXAMPLE

This application example demonstrates how to configure communication between a **PAC measuring** device and a **BACnet network** with a gateway project.

[Learn more >](#)

SOFTWARE SOLUTIONS

MBS SOFTWARE SOLUTIONS FOR THE INDUSTRIAL AND BUILDING AUTOMATION



BE

BACeye/SC

The “Swiss army knife” for building automation now available for BACnet Secure Connect

[Learn more >](#)



BTF

BACnet TEST FRAMEWORK

This reliable, automated tool makes pre-testing faster, less labor-intensive, and therefore more cost-effective.

[Learn more >](#)



B2O

BACnet-2-OPC

“BACnet-2-OPC” transmits BACnet data from building automation to a central management system via OPC UA or DA.

[Learn more >](#)



DS

DALI-STACK

Develop DALI-compatible devices according to the DALI 2 standard within a very short time and reduce your costs significantly.

[Learn more >](#)



MOS

M-BUS OPC SERVER

Data will be transferred from connected M-Bus meters to OPC-based applications.

[Learn more >](#)

MBS offers a wide range of software solutions for industrial and building automation. Rely on our many years of expertise for smooth communication.

THIRD PARTY PRODUCT

BACnet STACK



Stress-free path into the BACnet world

Anyone thinking about bringing devices or software packages for building automation to market on the basis of BACnet must decide whether or not they should develop the network protocol themselves or opt for a software stack instead. The stacks from CS-Lab as well as our services take the pressure off both manufacturers and developers alike, who need to implement the communication standard, and this makes their work a whole lot easier.

The BACnet standard (Building Automation and Control Networks) now holds a market share of over 60 per cent – and rising. This is because the ISO 16484-5 standard protocol defines services, object types and four-layer communication. This way, together with a conformity check, it ensures interoperability between various devices and fieldbus systems of building automation (BA). However, the impressive market share should not hide the fact that development work is a very complex process – experience tells us that even experienced users need more than a man-year for this depending on the complexity of a project.

[Learn more >](#)

The be-all and end-all for developing BACnet-compliant applications

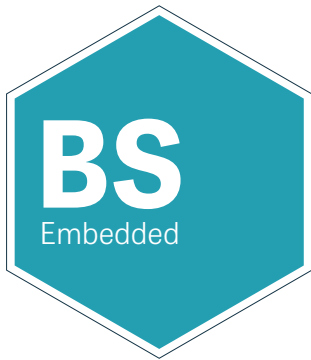

Embedded

The functional scope of the BACnet Stack | Embedded for Micro Controller is suitable for the development of BACnet servers according to profile B-SS, B-SA, B-ASC and B-AAC.

[Learn more >](#)



Linux (Posix)

The functional scope of the BACnet Stack | Linux (Posix) is suitable for the development of BACnet servers and clients according to profile B-BC, B-SS, B-SA, B-ASC, B-AAC, B-OD, B-OWS and B-AWS.

[Learn more >](#)



Windows

The functional scope of the BACnet Stack | Windows is suitable for the development of BACnet servers and clients according to profile B-BC, B-SS, B-SA, B-ASC, B-AAC, B-OD, B-OWS and B-AWS.

[Learn more >](#)

All variants support the data layers: IP, Ethernet and SC.
The variants for Linux and Embedded also support MS/TP.

