



MANUAL

Universal BACnet Router

UBR-01 | Mk II

Table of contents

1	Introduction.....	3
2	Safety.....	5
3	Classification and purpose.....	7
4	Features.....	8
5	Specifications and connected loads.....	12
6	Installation	14
7	Configuration.....	17
8	Reset.....	45
9	Product support	46

1 Introduction

Notation and symbols used

Notice	
The following notation and symbols are used in this manual.	
<Buttons>	The following notation and symbols are used in this manual.
	Graphic symbols are also used for buttons where suitable.
Network commands as well as file and product names	Network commands, such as <i>traceroute</i> or <i>ping</i> , are written in italics. The same applies to <i>file</i> and <i>product names</i> .

Copyright protection

This document is protected by copyright. Reproduction, reprinting, even of extracts, as well as reproduction of the images, even in a modified state, is only permitted with the written consent of the manufacturer.

Warranty

This manual must be read carefully before installing and commissioning the device. The warranty entitlement lapses if the device is installed by untrained personnel. Harm caused by disregarding the allowable connected loads and ambient conditions or by using unsuitable tools is also excluded.

Limitation of liability

All information and notes in this manual were compiled taking the applicable standards and regulations, best engineering practice and the manufacturer's extensive knowledge and experience into consideration.

The manufacturer assumes no liability for indirect and direct damage due to:

- Ignorance of this manual,
- Improper use,
- Use of untrained personnel,
- Damage due to incorrect installation,
- Unauthorized modifications to the hardware and software,
- Use of non-approved components.

The obligations agreed in the delivery contract, the general terms and conditions as well as the manufacturer's delivery conditions and the legal regulations applicable at the time of the conclusion of the contract apply.

Target group

This manual is intended for qualified personnel who are familiar with the configuration of devices and networks in building and industrial automation.

Intended use

The device is intended exclusively for coupling networks in building and industrial automation, with the connection values specified in the technical data.

Notice

This manual is part of the product and must remain with the end customer.

2 Safety

General

The hardware and software present no direct hazards. However, in their function as a gateway between networks in building infrastructures, they are able to seriously disrupt the interaction of network components.



Warning

Misconfiguration of hardware and software!

Faulty configuration of hardware and software can cause malfunctions in the building infrastructure on network components, sensors or actuators, **for example:**

- Monitoring devices, such as fire alarm or intrusion detection systems, are deactivated.
- Machines and fans start up unexpectedly.
- Gate valves and other valves open or close unintentionally.

Under certain circumstances, this can lead to serious injuries or death.

The configuration of the device may only be carried out by qualified personnel who are familiar with the network configuration!

No connection to a network may be established before the device has been completely configured!



Warning

Electric shock hazard!

When installing and connecting the device, live parts of the overall system in the control cabinet or other system parts may come into contact.

Under certain circumstances, this can lead to serious injuries or death.

Electrical devices may only be installed and connected by qualified electricians.

Notice



Operation of this device may cause radio interference in residential areas. In this case, the operator may be required to take appropriate measures and to pay for them (EN 55032).

3 Classification and purpose

Classification The devices of the UBR (Universal BACnet Router) product family, with their different interfaces, serve as BACnet router between different BACnet networks.

Purpose Router from BACnet IP to BACnet MS/TP. The router can be used as a BACnet router to connect a MS/TP bus to a BACnet IP network.

Standalone BBMD

The router can act as a BBMD in BACnet networks. The BBMD functionality is used to transport broadcast messages across network boundaries (IP switches) and thus make them available in the other subnet. Without the use of BBMDs, broadcast messages are not transmitted over an IP switch.

Schematic structure of a typical BACnet network

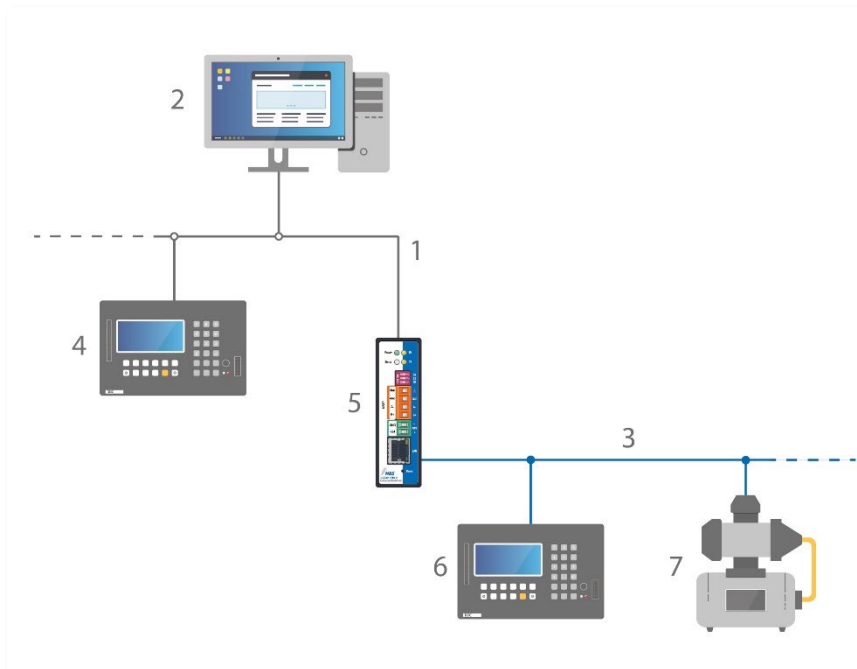

- 1 Ethernet BACnet/IP
- 2 PC with projecting software or building control system
- 3 RS485 (two-wire network)
- 4 DDC automation station
- 5 MBS universal BACnet router
- 6 DDC automation station
- 7 Field device, e.g. pump

4 Features

BACnet

BACnet Protocol Revision;
the router is compliant with **BACnet version 1 protocol revision 22**.

Diagnostics;
the router has extensive diagnostic capabilities to assist with commissioning and to monitor function during operation.

BACnet-IP

BBMD – BACnet Broadcast Management Device;
the router can be configured as a BACnet Broadcast Management Device (BBMD). The connection of Foreign Device (FD) is supported in BBMD mode.

FD – Foreign Device;
the router can be registered as a foreign device with a BBMD present in the network. By the registration the router becomes part of the BACnet/IP network and receives broadcast messages from other subnets which are provided by the BBMD.

BBMD IP Filter;
using the BBMD-IP Filter function, it is possible to control from which devices broadcasts are forwarded from the IP subnet via the BBMD functionality. Individual devices can be excluded via the filters in order to prevent broadcasts from these devices from being transported beyond the limits of the IP subnet.

BACnet MS/TP

The router works as a master on the MS/TP bus and supports the following baud rates: 9,600 / 19,200 / 38,400 / 57,600 / 76,800 / 115,200.

The bus terminating resistor and the network bias resistors can be activated via the DIP switch. The RS485 interface (BACnet MS/TP) is potential-free.

Slave Proxy

The router can be configured as a "slave proxy" and responds to "Who-Is" requests with an "I-Am" message on behalf of connected MS/TP slave devices. The slave proxy option allows other BACnet devices to find the connected MS/TP slave devices in the network without having to configure the slave addresses in each device individually.

In addition to manual configuration, the router also has the capability of automatic configuration.

BACnet/SC Topology

First of all, the network topology of BACnet/SC looks different.

Previously, broadcasts were used for initial connection attempts in BACnet, partly with the support of BACnet Broadcast Management Devices (BBMD) – not a commonplace method in the IT field.

A different approach has now been chosen for the configuration.

Each network is given a central point, the so-called hub. It controls the data traffic between any number of nodes (end devices). It also analyzes the traffic to determine whether information should be forwarded to a single node or to all nodes.

A direct connection can also be configured for direct communication between **two** nodes.

Furthermore, BACnet/SC includes a failover mechanism that ensures that the system remains operational even if the hub fails or is switched off for maintenance. This new topology greatly simplifies configuration, commissioning and management. At the same time, BBMDs and their configuration become obsolete.

Structure of a typical BACnet/SC network

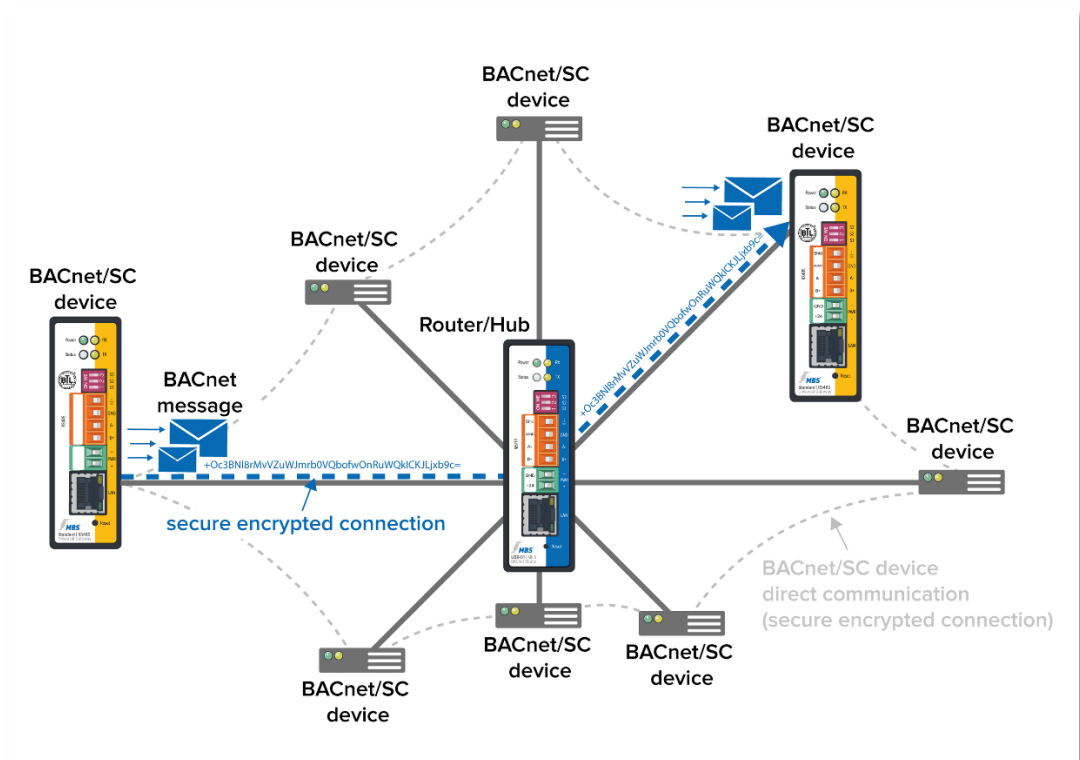

BACnet/SC Encryption and certificates

TCP (Transmission Control Protocol) and WebSocket – two reliable mechanisms based on the internet protocol (IP) widely used in IT – are used for secure data transmission. TCP/IP replaces the UDP (User Data Protocol) network protocol layer previously used by BACnet; TLS is used to ensure bug-proof and tamper-proof communications. TLS (Transport Layer Security) is also widely used as the foundation for secure internet access (https) in IT.

As far as encryption is concerned, a company-wide procedure must be put in place for the necessary digital certificates.

The certification and registration authorities responsible for the internet in connection with public key infrastructures are not specified in BACnet/SC. This means building automation operators can take account of their individual network structures.

To ensure problem-free implementation in existing networks, the security mechanisms have been defined in BACnet as an additional data link layer.

The new standard in the latest **revision 22** is also downwardly compatible. The advantage of this is that the existing system can always communicate with the new BACnet/SC devices via appropriate routers.

Notice

The configuration of **BACnet/SC connections** is described in this document under BACnet settings (page 32).

5 Specifications and connected loads

Casing	Metal casing for top-hat rail mounting
Protection class	IP20
Assembly	DIN top-hat rail TS35 according to EN 60715
Weight	250 grams
Ambient temperature	0–45 °C, 32–113 °F
H/W/D dimensions in millimeters	100 / 30 / 70 (including DIN top hat rail adapter)
Lateral spacing to other devices	≥ 15 mm
Ambient humidity	20–80 percent relative humidity, non-condensing
Power supply	9-24 volts DC or 9-24 volts AC, 200 mA, wide range input, protective extra-low voltage (PELV), LED for indication of power supply
Power consumption	1,7 watts
Ethernet	10/100 Mbit, TP RJ45 socket
MS/TP	4-pole Weidmüller socket with the connections: B(+), A(-), SGND (Signal Ground), SHLD (cable shield) LED TX and RX to display sending and receiving data

Notice



Operation of this device may cause radio interference in residential areas. In this case, the operator may be required to take appropriate measures and to pay for them (EN 55032).

6 Installation

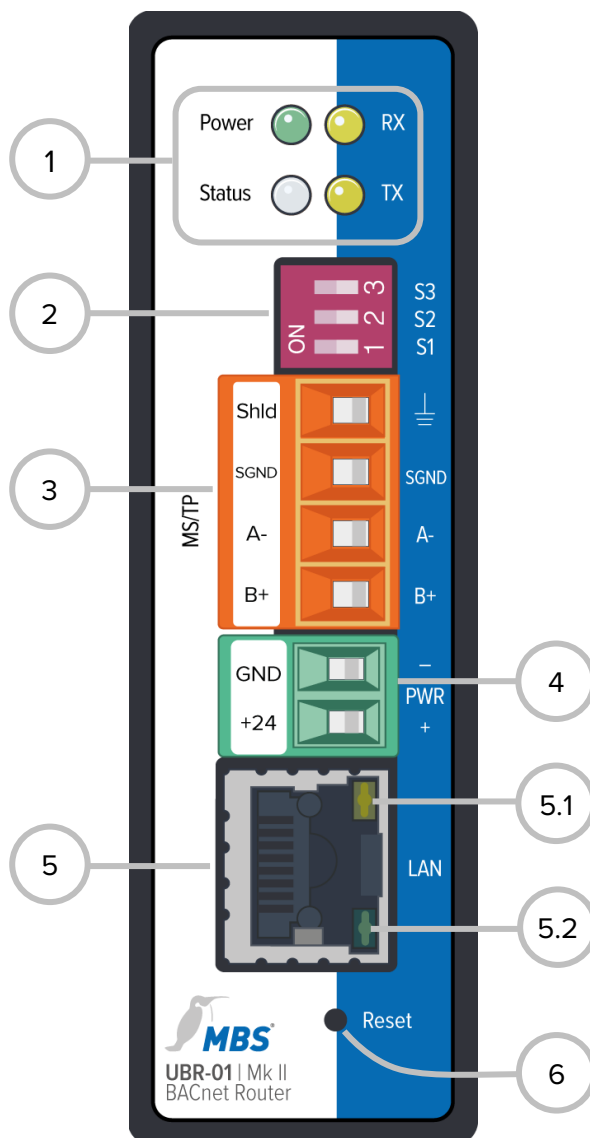

1 LED

Power	Power supply status
RX	Receiving data MS/TP
TX	Send data MS/TP
Status	Router status (Multicolor LED)

2 DIP switch

S1	Bias voltage for RS485 interface
S2	Bias voltage for RS485 interface
S3	120 Ohm termination impedance

3 MS/TP RS485

Shld	Shielding
SGND	Signal ground
A-	Inverted wire
B+	Non-inverted wire

4 PWR

GND	ground
+24	Supply voltage 12-24 V, DC or AC, PELV

5 LAN Ethernet RJ45

5.1	LED 10/100 Mbit/s
5.2	LED Link/Activity

6 Reset

Assembly / Disassembly

The device must be mounted on a top-hat rail (DIN top hat TS35 according to EN 60715). The top-hat rail bracket is pre-assembled on the back of the device. The bracket is hooked into the top-hat rail from above and fixed to the underside of the bracket with a clearly perceptible click.



Warning

Electric shock injury hazard!

The device may only be installed in a control cabinet (top-hat rail) when the power is disconnected.

The system must be disconnected for installation.

Notice

A sufficient distance ($\geq 15 \text{ mm}$) to the other components on the top hat rail is recommended for mounting the device in the control cabinet.

This ensures better heat dissipation, which can have a positive influence on the service life of the device.

Disassembly is carried out by unlocking the bracket on the underside and carefully removing it from the top-hat rail.

Notice

Connecting cables should be unplugged during disassembly, to avoid damage.

Power connection

The device is **exclusively** operated with protective extra low voltage (PELV). The permissible voltage range must be taken from chapter 5 *Specifications and connected loads*.



Warning

Electric shock injury hazard and damage to device!

Connecting the device to deviating, excessively high supply voltages may lead to serious injuries or death.

The device is operated exclusively with Protective Extra-Low Voltage. No supply voltages that deviate from the connection values specified in the *Specifications and connected loads* may be used.



The device is supplied with a reverse polarity protected plug that is already pre-assembled in the [PWR] socket. To connect the supply lines, it is recommended to remove the plug. The cable cores are connected and screwed according to the marking [+24 / GND].

RS485 Bias voltage

The bias voltage for the RS485 interface is switched with the DIP switches **S1** and **S2**. The bias voltage is active when they are **both** set to the ON position. The default setting for all DIP switches is OFF..

Notice



Switches **S1** and **S2** must always be switched **together** to avoid transmission interference on the MS/TP bus.

RS485 Bias termination

S3 provides a switchable 120 Ohm terminating resistor that terminates the end of a segment in an MS/TP network. Termination may only be done when the device is at the end of such a network segment.

7 Configuration

Network connection

For configuration, the device must be connected to the computer using a network cable.

The computer then **automatically** (APIPA) receives a free IP address in the address range 169.254.x.x and can communicate directly with the device.

If there is no direct (point to point) connection between the device and the computer or if the IP address is not assigned automatically, it must be configured manually on the computer (e.g. IP address 169.254.0.5 / subnet mask 255.255.0.0).

Notice

It is important that the manually configured IP address is not already in use by other devices on the network.

The way to configure the network connection on the computer depends on its operating system.

Under **factory settings**, the web server is accessible at the following IP address:

IP address	169.254.0.1
Subnet mask	255.255.0.0

Web server

The device has an integrated web server for configuration. The web server provides the configuration settings in the form of websites.

Login

To call up the configuration interface, the following address is entered:
http://169.254.0.1 or **https://169.254.0.1**

To log in to the web server for the first time, the user name and the preset password must be entered.

User name	admin
Password	admin

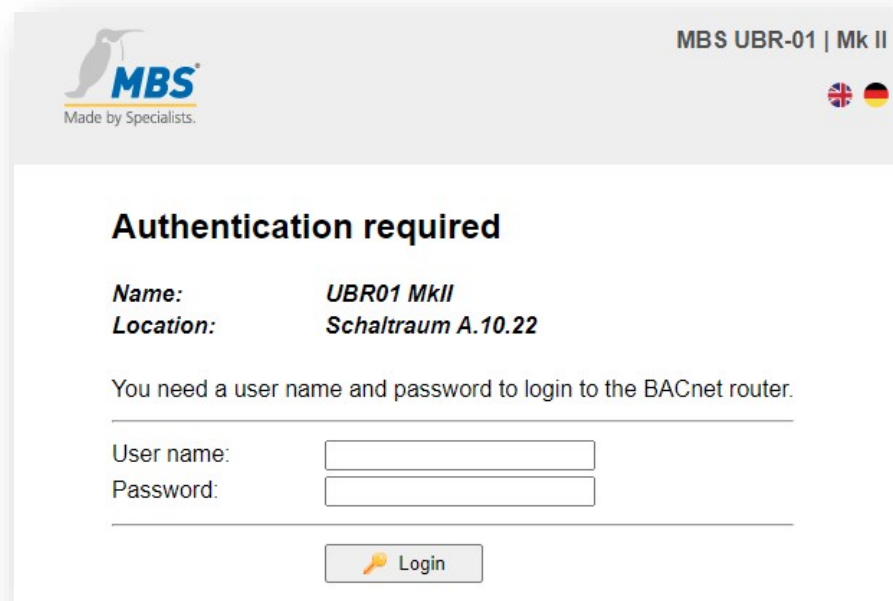

Password security

After logging in, it is strongly recommended to change the password and keep it safe.

Important notice

The preset password cannot be restored by a hardware reset!

Passwords can be reset only if the *SSH* option has been enabled before.

HTTPS

For a connection via https (Hypertext Transfer Protocol Secure), the device has its own security certificate when delivered.

Usage



Hinweis

To be compliant with this guide, set the language of the web server to English by clicking the icon.



Hinweis

To update the views in the web server, the REFRESH button must always be used.

If the refresh button of the web browser is used, the web server will be logged out.

Some configurations require the device to be restarted. This is indicated in these instructions with **<restart required>**. The web server shows at the top of the screen of the adjacent button.

Menu structure

The menu structure of the web server is described in this manual in the categories **GENERAL / BACNET / DIAGNOSTICS / HELP**. These categories are structured into their corresponding subitems.

GENERAL

Overview





Shows basic device data and the current system status. The device data can be changed under General / Details.

Type:	Device type
Name:	Designation
Location:	Installation location
Description:	e.g. Universal BACnet Router
System start:	last system start
CPU load:	current CPU load
Free system memory:	free / occupied in MByte

GENERAL

Details

Allows to change organizational data of the device.

Notice																	
	All entries require a final <Save>.																
	All entries are free texts. The size of the entry fields can be adjusted with the mouse (bottom right corner).																
	Contact persons 1 and 2 can additionally be deposited with an image. The image is also deleted again at this point.																
	<table border="1"> <tr> <td>Name:</td> <td>Free text, device name in network</td> </tr> <tr> <td>Location:</td> <td>Free text, Installation location</td> </tr> <tr> <td>Description:</td> <td>Freitext, z.B. BACnet Router</td> </tr> <tr> <td>Contact person 1:</td> <td>Free text, Name of person(s)</td> </tr> <tr> <td></td> <td>Image (exactly 80x160 pixels), for person or logo</td> </tr> <tr> <td>Contact person 2:</td> <td>Free text, Name of person(s)</td> </tr> <tr> <td></td> <td>Image (exactly 80x160 pixels), for person or logo</td> </tr> <tr> <td>Show on login:</td> <td>Shows the above information already in the login screen. Images are not shown.</td> </tr> </table>	Name:	Free text, device name in network	Location:	Free text, Installation location	Description:	Freitext, z.B. BACnet Router	Contact person 1:	Free text, Name of person(s)		Image (exactly 80x160 pixels), for person or logo	Contact person 2:	Free text, Name of person(s)		Image (exactly 80x160 pixels), for person or logo	Show on login:	Shows the above information already in the login screen. Images are not shown.
Name:	Free text, device name in network																
Location:	Free text, Installation location																
Description:	Freitext, z.B. BACnet Router																
Contact person 1:	Free text, Name of person(s)																
	Image (exactly 80x160 pixels), for person or logo																
Contact person 2:	Free text, Name of person(s)																
	Image (exactly 80x160 pixels), for person or logo																
Show on login:	Shows the above information already in the login screen. Images are not shown.																

GENERAL

IP network

Allows to make the configurations to the IP network.

Notice

All changes require a final <save> and <restart>.

Network adapter LAN1	IP address:	Entry of the IP address
	Netmask:	Entry of the subnet mask
Default Gateway	Gateway:	Entry of the IP address of the default gateway (optional)
Advanced IP-Routing	<Add>	Creates a new IP routing item
	Type <net>	Selection via destination network
	Type <host>	Selection via destination host
	Adapter <LAN1>	Selection of the network adapter
	IP:	IP address / prefix of the netmask
	Netmask:	Entry of the netmask
	Gateway:	Entry of the IP address of the gateway for this routing item
Network name	Hostname:	Device name in the network
	Nameserver 1:	IP addresses for nameservers for name resolution (DHCP)
	Nameserver 2:	
Services	Web server access:	communication via: http (port 80) unencrypted; https (port 443) encrypted; or both.
	enable ssh access:	SSH access (encryption) on/off

GENERAL

IP network For the connection via **https** (Hypertext Transfer Protocol Secure), the gateway comes with its own security certificate as delivered.

System time Enables settings for the system time of the device.

Three time modes can be selected. Furthermore, time zone, time and date format of the device can be configured.

Notice

All changes require a final <save> and <restart>.

Manual time setting	The system time (date and time) is set manually and runs independently of other network timers.	
	<REFRESH>	Applies the current time of the computer
	<Set time>	Saves the set time in the device
NTP time synchronization	NTP Server	receives the time information from the registered NTP server
Evaluate BACnet time synchronization	The device listens to sent BACnet messages for time synchronization and processes them adequately.	

GENERAL

User

The device has three preset users: *guest*, *user* and *admin*.

Notice

Each of these users has certain access rights. Names and permissions of the three users are fixed and **cannot be changed**.

Permissions for	guest	user	admin
General – Overview	x	x	x
General – Details	-	x	x
General – IP network	-	x	x
General – System time	-	x	x
General – User	-	(x)	x
General – Backup/Restore	-	x	x
General – Update	-	-	x
General – Restart	-	x	x
BACnet – Settings	-	x	x
BACnet – Device-object	-	x	x
Diagnostics – Statistics Routing	-	x	x
Diagnostics – Statistics Datalink	-	x	x
Diagnostics – MS/TP devices	-	x	x
Diagnostics – Packet logging	-	x	x
Diagnostics – WSSC connections	-	x	x
HELP – Info about	x	x	x
HELP – BACnet PICS	x	x	x
HELP – System – Logfiles	-	x	x

Permissions for	guest	user	admin
HELP – System – Ping	-	x	x
HELP – System – Traceroute	-	x	x
HELP – System – Process information	-	x	x

User

Allows to manage the users.

Notice

Changes are applied only with <Save>.



The users *guest* and *user* can be deactivated.

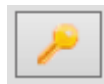

With this button the password of the respective user can be changed.



Automatic login as guest

Calling the WEB server always leads automatically to the account *guest*. Only after logging out as *guest*, another user can be selected.

GENERAL

Backup/Restore

Allows the configuration of the router to be saved to or restored from a disk.

<input type="radio"/>	Backup device configuration	With <Start>, a location for the configuration file ubrbackup.tgz is selected. The file name is freely selectable.
<input checked="" type="checkbox"/>	include certificates	Including certificates to a backup is a potential security risk!
<input type="radio"/>	Restore device configuration	With <Datei auswählen> a configuration file is selected from a disk. Press <Start> to start restoring the saved configurations.

Notice

When restoring the data backup, all current configurations are lost!

This warning message appears:

ATTENTION: If you restore the backup archive, the current configuration will be lost.

Do you really want to restore the archive?

Press <Start> to begin the process.

The device then automatically performs a restart.

GENERAL

Update

Enables a file to be transferred to the device that contains a software update. The current software version is also displayed here.

Notice

Here only a file may be selected, which was provided by the manufacturer of the system. The name is obligatory "*update.upd*".

Press <Start> to start transferring the file to the device. The update is not yet executed during the transfer. This only happens when the device is restarted once.

Notice

The configuration is not changed by an update.

Restart

The device can be specifically restarted here.

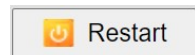

The restart is performed to accept configuration changes. It should be completed after approximately 30 seconds.

Notice

With the selection 'complete restart' the hardware is restarted. This is equivalent to switching off and on again.

The device will not transfer any data for a few minutes afterwards. The configuration is completely retained.

The device cannot perform its function in the network during the restart. The web server cannot be reached during the restart.

BACNET

Settings

Enables the configuration of the device for the BACnet data connections. With <Save> the changes are accepted.

<Refresh> updates the display. <Restart required>.

Router mode:	BACnet IP only	Communication BACnet IP only. One data link for BACnet IP is specified.
	BACnet MS/TP only	Communication BACnet MS/TP only. One data link for BACnet MS/TP is specified.
	BACnet IP and MS/TP	Communication BACnet IP + BACnet MS/TP. One data link for BACnet IP and one data link for BACnet MS/TP are specified.
	Non default configuration	Users can freely configure the number and type of data links.

Hinweis

BACnet/SC is configured in the router mode "no default configuration".

BACNET

Settings

Data link Link-Typ <i>IP</i> 	Network number	Sets the network number of the BACnet network for the data link. Value is in the range from 1 to 65,534.
	LAN name	Defines the interface of the datalink. E.g. <LAN1>
	UDP-Port	Sets the UDP port of the BACnet/IP network as a decimal number. Default value is 47.808.
	IP mode	Sets the IP mode of the router for this datalink. Normal: Default operating mode for a BACnet IP datalink. BBMD: Operating mode as "BACnet Broadcast Management Device". Foreign Device Operating mode as "Foreign Device".

BACNET

Settings

Data link Link-Typ mstp 	Network number	Sets the network number of the BACnet network for the data link. The value is in the range from 1 to 65,534.
	MAC address	<p>Sets the BACnet MAC address of the router operating as the MS/TP master node. Values range from 0 to 127, the default value is 0.</p> <p>The MAC address must be unique within the MS/TP network, but may be repeated in other MS/TP subnets of the entire BACnet network.</p>
	Serial interface	Sets the interface of the datalink.
	Baud rate	<p>Speed (bit/s) to match the other MS/TP components used.</p> <p>Possible values are: 1200, 2400, 4800, 9600, 19200, 38400, 57600, 76800 and 115200 baud.</p> <p>Default value is 38400 baud.</p>
	Max. Master	<p>Sets the highest MAC address for master nodes in the MS/TP subnet (0...127).</p> <p>Default value is 127.</p>
	Max. info frames	<p>Defines the maximum number of telegrams that a master node may send before the token must be passed on. (1...127).</p> <p>Default value is 1.</p>
	Token timeout	Minimum amount of time without a “Data Available” or “Receive Error” event, that a node must wait for a remote node to use a

	<p>token or respond to a “Poll For Master” request. Value range between 20 and 100 milliseconds.</p> <p>Default value is 20.</p>
Reply timeout	<p>Minimum time without a "Data Available" or "Receive Error" event that a node must wait for a station to respond to a “Confirmed request”. Value range is between 200 and 300 milliseconds.</p> <p>Default value is 250.</p>
Enable slave proxy operation	<p>As a "Slave Proxy", the router responds to "Who-Is" requests with an "I- Am" message on behalf of connected MS/TP slave devices.</p> <p>The slave proxy option allows other BACnet devices to find the connected MS/TP slave devices in the network without having to configure the slave addresses in each device individually.</p>

BACNET



Settings

The configuration of **BACnet/SC** connections is done in the BACnet data connections, in router mode "Non default operation".

BACnet Datalinks

Property	Value
Router mode:	Non default operation ▾
Non MS/TP discovery delay:	0 seconds
Password DCC/RD:	UBR

Datalinks:

Port-Id	Network-No.	Link-type	Details	
1	1	mstp	MAC:0 COM1 Baud rate:1200	
2	2	ip	Mode:ip LAN1 UDP port:47808	

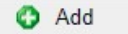
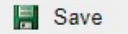
 Add
  Save

Notice



The properties of the data connection 'mstp' are called up with the edit button. The link type is set there to "Secure Connection".

BACnet Datalink ✕

Parameter	Value
Link-Type:	IP ▾
Network number:	IP
LAN name:	MS/TP
UDP port:	Ethernet
IP mode:	Secure Connection



Ok Delete Cancel

Connection	Security	Virtual MACs	Direct connections
------------	----------	--------------	--------------------

Connection		
LAN name:		Selects the relevant network.
TCP Port:		Sets the TCP port, e.g. 47809
Node mode:		Selection of <i>Normal Node</i> , <i>Primary Hub Node</i> or <i>Failover Hub Node</i> , defines the function of the BACnet/SC device.
VMAC address: (VMAC)		Here a unique VMAC can be explicitly assigned or randomly generated. e.g.: <i>d728ae328d3b</i>
Node ext. visible URI:		The externally visible URI of this node is defined here.
Primary Hub URI:		The URI of the primary hub is set, e.g.: <i>wss://192.168.118.25:47809</i>
Failover Hub URI:		The URI of the <i>failover hub</i> is set here.
Alive check interval:		Default 300 seconds
Connect timeout:		Default 5 seconds
Reconnect delay:		Default 5 seconds
Reconnect retries:		Default 5
URI Cache timeout		Default 3600 seconds
Use websocket Ping		Enable Websocket Ping

	Connection	Security	Virtual MACs	Direct connections
Certificate	Create Certificate Request:		<Create CRT> for requesting a certificate and managing these requests.	
	CA Certificates:		<Upload> the certificate file for client authentication.	
	Server Certificate:		<Upload> the certificate file for server authentication.	
	Server private key:		<upload> of the private key for server authentication.	
	Accept selfsigned cert.:		Self-signed certificates are accepted.	
	Accept invalid host cert.:		Certificates that contain invalid hostnames are accepted.	
	Accept expired cert.:		Certificates with expired validity are accepted.	
	Accept any server cert.:		Any server certificate is accepted without verification.	
	Accept any client cert.:		Any client certificate is accepted without verification.	
	Server checks client cert.:		Verification of client certificates is enabled.	
Security Level	Accept SSL v2 connections		<input checked="" type="checkbox"/>	
	Accept SSL v3 connections		<input checked="" type="checkbox"/>	
	Accept TLS 1.0 connections		<input checked="" type="checkbox"/>	
	Accept TLS 1.1 connections		<input checked="" type="checkbox"/>	
	Accept TLS 1.2 connections		<input checked="" type="checkbox"/>	

	Connection	Security	Virtual MACs	Direct connections
Virtual MACs	VMAC address table management		Mapping the VMAC to the nodes connection URI: e.g. „90d195d198bd“ to „wss://B1.THK:47809“	

Virtual MAC address table:		
Virtual MAC address:	Nodes connection URI:	
90d195d198bd	wss://B1.THK:47809	
 Add		

The VMAC is the virtual MAC address that is used under BACnet/SC to address data requests and responses that are sent or requested by the BACnet application. The virtual MAC address is then translated into the actual target URI in the BACnet/SC data link using a table and the data is then sent to the respective node via this URI.

The fact that a virtual address is used instead of the target URI or target IP address is due to a restriction in the BACnet network layer, which only allows addresses with a maximum length of 8 bytes.

But since BACnet/SC should also work for IPv6 (with 16 byte addresses), virtual VMACs are used.

Direct connections enable communication between nodes in BACnet/SC without the involvement of a hub.

Direct Connections (DC)	Global Configuration:	Accept connections: Control of direct connection between <i>Normal nodes</i> . Incoming connections are allowed.
		Initiate connections: Control direct connection between <i>Normal nodes</i> . Outgoing connections are allowed.
		Allow not configured DC: Also not explicitly in the table ' <i>Direct connection configurations</i> ' (see below) are allowed.
		Direct Connection idle count: Setting the number of pings. To maintain the connection, a ping is sent and a pong is expected at certain intervals. If more than maximum idle count ping / pongs have been sent without another packet with user data being sent or received, then the connection is terminated because no more useful payload data is being transmitted (alive check).
	Direct connection configurations:	Virtual MAC address: z. B.: „d728ae328d3b“
		Allow connection: Switch this defined connection on or off.
		Maximum idle count: see " <i>Direct Connection idle count</i> "

BACNET

Device-object

Enables the configuration of this device for the BACnet.
 With <Save> the changes are accepted. <Refresh> updates the display. To finish <Restart required>.

Device-Instance:	Defines the device instance number of the router which must be unique within the entire BACnet network. The value range of this property is between 0 and 4.194.302.
Device-Name:	Defines the device name of the router, which must be unique across the entire BACnet network.
Device-UUID:	Universally Unique Identifier is a 128-Bit-number for device identification, <i>e.g. 4fbb6794-9c57-4b6c-88f8-d728ae328d3b</i>
Description:	Sets the BACnet description - a free description text - of the device.
Location:	Sets the BACnet location - a free text for the installation location - of the device.
Vendor-Identifier:	Manufacturer ID for unique identification of the device manufacturer
Vendor-Name:	Unique name of the device manufacturer
Model-Name:	Type designation
Firmware-Revision:	Firmware version of the device software
APDU Max-Length-Accepted:	Maximum telegram size in Byte. Possible are: 50, 206, 480, 1024 und 1476 Byte.

<p>APDU Timeout:</p>	<p>Defines after which time period a telegram requiring acknowledgement, is evaluated as failed if the acknowledgement is missing.</p> <p>Default value is 3,000 milliseconds.</p>
<p>APDU Retries:</p>	<p>This value determines how often a failed telegram is to be repeated.</p> <p>Default value is 5.</p>
<p>APDU Segmentation-Supported:</p>	<p>Possible values: 0-Both, 1-Transmit, 2-Receive, 3-No</p>
<p>APDU Max-Segments-Accepted:</p>	<p>Sets the maximum number of segments that will be accepted.</p>
<p>APDU Segment-Timeout:</p>	<p>Value determines after which period of time an acknowledgment-requiring, segmented telegram is evaluated as failed, if the segment confirmation is missing.</p> <p>Default value is 2,000 milliseconds.</p>

DIAGNOSTICS

Notice

In the information provided here is data that may be helpful in commissioning and diagnostics. This information is **not** complete, but helps to get information in a first step. For further diagnostics the BACnet explorer *BACeye* is recommended.

Notice



To refresh the diagnostics view, this <button> must be used.



To reset the recordings, this <button> must be used.

Statistics Routing

Provides the evaluation of the routing statistics since router start and since last <Reset>. <Refresh> refreshes the display.

Routing statistic	Total data of the packets routed.
NPDU type counts	Counts itemized by NPDU type
APDU type counts	Counts itemized by APDU type
Confirmed service counts	Counts of confirmed services, itemized by service.
Unconfirmed service counts	Counts of unconfirmed services itemized by service.
Object type counts	Count itemized by object type.

Statistics Datalink

Provides statistical analysis of data connections since router start and since last reset.

Datalink Port Id 1 <no.> - ip - LAN1	Analysis the LAN <no.> IP protocol
Datalink Port Id 2 <no.> - mstp - COM1	Analysis the LAN <no.> MS/TP protocol

MS/TP devices

Displays the MS/TP devices in the network, separated into master and slave devices.

Network number	Network number of the BACnet network.
MS/TP MAC address	BACnet MAC address of the MS/TP bus device
System status	System state of the MS/TP bus device.
Device instance	BACnet Device-Instance of the MS/TP bus device.
Device name	BACnet Device name of the MS/TP bus device.
Description	BACnet-Description of the MS/TP bus device.
Installation location	Installation location of the MS/TP bus device.
Vendor Model	Vendor ID and model name of the MS/TP bus device.
Max-APDU-Size	Max-APDU-Size, which the device can process.
Max-Master	Information for Max-Master of the MS/TP bus device.
Max-Info Frames	Information about the Max-Info frames of the MS/TP bus device.
Protocol-Revision	Information on the implemented BACnet protocol revision of the MS/TP bus device.

Firmware-Revision	Firmware revision of the MS/TP bus device
Application-Version	Applications version of the MS/TP bus device

Packet logging

Provides the ability to record data links.

All	Recording all networks
Port-Id: Network No.:1 Typ: IP	Network 1, with IP protocol
Port-Id: Network No.:2 Typ: mstp	Network 2, with IP MS/TP
All frame types	All packet frame types
Only addressed frames	Addressed frame types only
<Start> / <Stop>	starts / stops the recording
<Delete>	deletes the recordings

WSSC connections

Shows the details for the **Web**Socket**Secure**Connections, that is the BACnet/SC connections, divided into the following connection types:

Incoming direct connections

Incoming hub connections

Outgoing connections

Primary hub connection

Failover hub connection

The following parameters are displayed:

Port-Id	
Connection-state	
Connection-attempts	
Connection-time	

Peer address	
UUID	
VMAC	
Supported BVLC bytes	
Supported NPDU bytes	
Sent frames	
Received frames	
Bad frames	
Bad replies	

HELP

Info about Details of the manufacturer of the device.

BACnet PICS Document on the conformity of the device to the BACnet standard. (BACnet Protocol Implementation Conformance Statement).

HILFE / System

Device info Displays the current device parameters.

Hardware type:	Device type e.g. UBR-MICRO7 21.2.1
Network adapter LAN x:	MAC address of the device in the LAN
Version:	e.g. UBR_5.0.0.1
OS-Version:	Version number of the operating system.
Build-Info:	e.g. „./build -t micro7 -o 267ea910 -g 11cdf52a -i ubr“
System start:	time of the last system start
Free system memory:	free memory / total memory in MByte
Last update:	Status of the last update

Logfiles Allows log files to be recorded.

<Start for 60 sec.>	Starts recording for 60 seconds.
<Stop>	Stops the recording.
<Show history log>	Lists the captured log entries.

Ping

Allows to check the accessibility of a destination address in the network:

<code>ping -c3</code>	Enter the destination address for which <i>ping</i> should be executed 3 times.
<Start>	Starts the execution of <i>ping</i> .
Example of the result of the <i>ping 168.152.32.60</i>	<pre>PING 168.152.32.60 (168.152.32.60): 56 data bytes -- 168.152.32.60 ping statistics -- 3 packets transmitted, 0 packets received, 100% packet loss</pre>

Traceroute

Allows to check the route to a destination address in the network. The routers passed in the process are displayed:

<code>traceroute</code>	Enter the destination address for which <i>traceroute</i> is to be executed.
Example of the result of the <i>traceroute 168.152.32.60</i>	<pre>traceroute to 168.152.32.60 (168.152.32.60), 30 hops max, 40 byte packets 1 ubr (168.152.32.40) 3001.037 ms !H 3001.155 ms !H 3000.792 ms !H</pre>

Process information

Displays the processes currently running in the device:

Example	Mem: 21304K used, 5568K free, 0K shrd, 932K buff, 13664K cached
	Prozessorauslastung (Beispiel)
	CPU: 0.0% usr 8.3% sys 8.3% nice 83.3% idle 0.0% io 0.0% irq 0.0% softirq
	Load average: 0.00 0.00 0.00
	Laufende Prozesse (Beispiel)
	<pre>PID PPID USER STAT VSZ %MEM %CPU COMMAND 699 698 nobody R N 1468 5.4 16.6 top -b -n1</pre>

8 Reset

Hard-Reset

With the hardware-reset button, the device can also be reset without calling up the configuration interface.

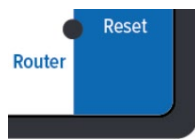

Notice

You can find the reset button on the front of the device. The button may only be pressed with a suitable tool.

Depending on the duration of pressing, the following changes are executed:

after 1 second	Restart (Status-LED flashes green quickly)
after 10 seconds	The IP address will be set to 169.254.0.1 (default) until the next restart (Status-LED flashes yellow quickly).
after 15 seconds	Factory reset (Status-LED flashes red quickly)

Notice

When resetting to factory settings, all previous configurations are lost. Passwords are NOT reset.

Soft-Reset

This reset is executed via the configuration interface under GENERAL / Restart.

See chapter *Configuration*.



9 Product support

Manufacturer	MBS GmbH Römerstraße 15 47809 Krefeld Germany
Telephone	+49 21 51 72 94-0
Fax	+49 21 51 72 94-50
E-Mail	support@mbs-solutions.de
Internet	www.mbs-solutions.de
	wiki.mbs-software.info
Service times	Monday to Friday: 8:30 to 12:00 13:00 to 17:00